

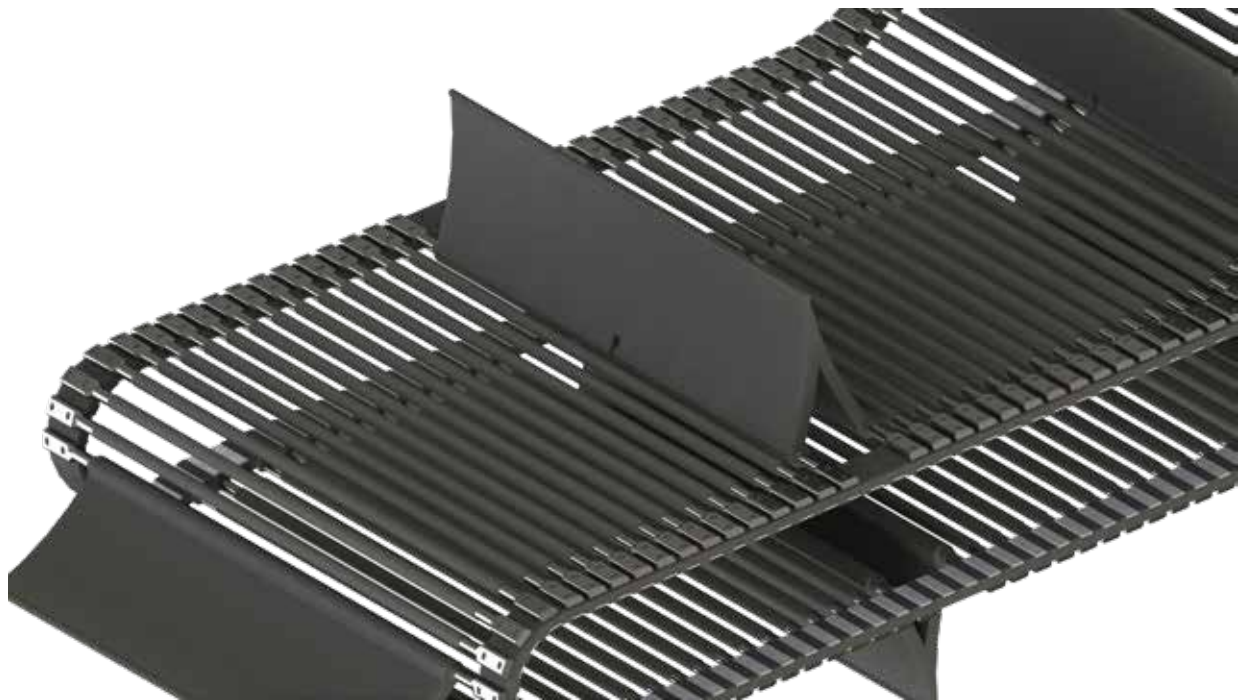

# BELTED CHAIN

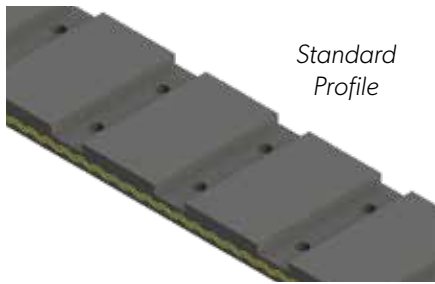

In 1978, belted chain was introduced into the Noffsinger production line. Our belted chain and components have a wide range of applications, including agricultural harvesters (potato, tomato, carrot, onion, sugar beet, etc.), crop sizers, grading and sorting lines, rock pickers/separators, as well as in continuous operation processing plants.



Standard Profile

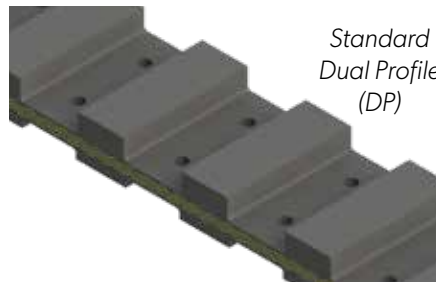

Standard Dual Profile (DP)

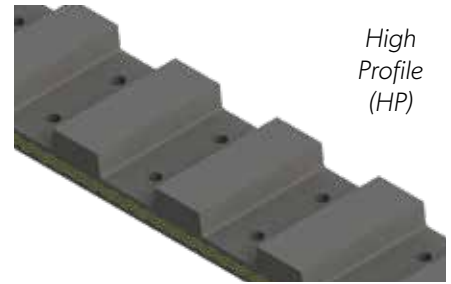

High Profile (HP)

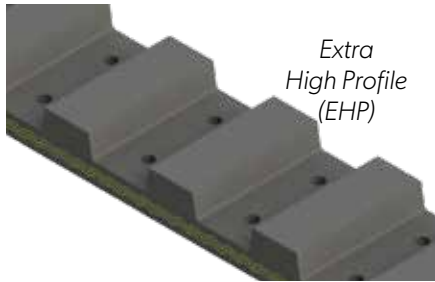

Extra High Profile (EHP)

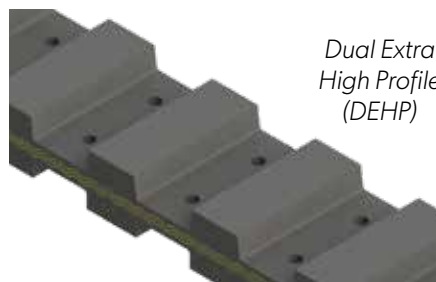

Dual Extra High Profile (DEHP)

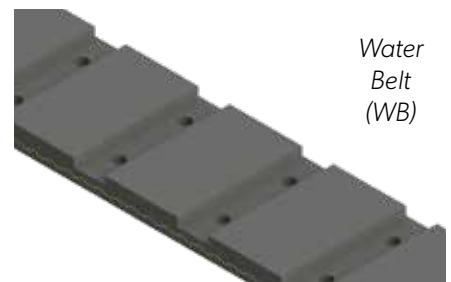

Water Belt (WB)

Noffsinger belting is manufactured to strict tolerance for use in belted chain. Common pitches include (mm) 28, 32, 36, 40, 42, 45, 50, 56, 60, 64, 150, 180. Additional profiles & pitches are available on request.

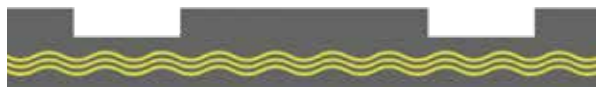

## STANDARD PROFILE

Our most common belting option, Standard belting is typically driven on the rods of the web.



## STANDARD DUAL PROFILE (DP)

Similar to Standard Profile, Standard Dual Profile allows the rods to recess into the belting for added bruise protection.

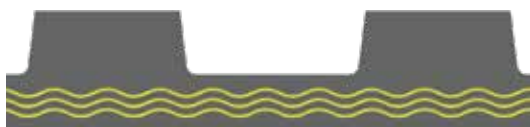

## HIGH PROFILE (HP)

High Profile belting allows for driving directly on the belting profile.



## EXTRA HIGH PROFILE (EHP)

Same as High Profile, Extra High Profile provides additional contact area for driving the belt.

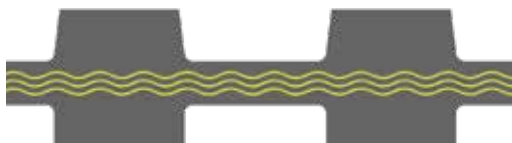

## DUAL EXTRA HIGH PROFILE (DEHP)

Driven like High Profile, DEHP can be driven by the belt while also providing bruise protection like Dual Profile.

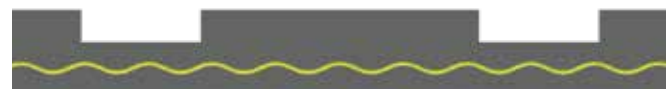

## WATER BELT (WB)

Using one solid extra strength 1000N fabric weave Water Belt is specially designed for high moisture applications.

*Standard Profile belting traditionally comes with 900N fabric weave, we also provide it with 1200N fabric for additional tensile strength and increased tear out protection.*

## THREADED JOINT CLIPS

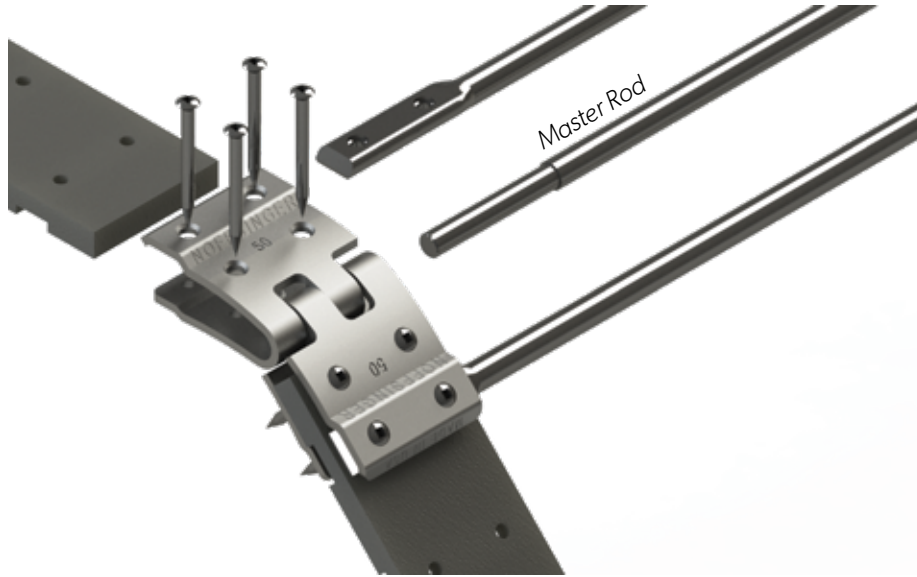

Master Rod



Master Pin  
109261



Bolt & Nut  
116330



Flex Link  
(Dog Bone)



## NON-THREADED (RIVETED) JOINT CLIPS



## LAP JOINT

Lap joints are available in 2, 3 and 4 pitch configurations. Lap joints are considered one of the more economical joining methods, providing high strength while maintaining most of the belt's flexibility. Rods can be threaded, or fastened by backing plate with a nut and bolt. Lap joints are typically used with larger diameter sprockets.

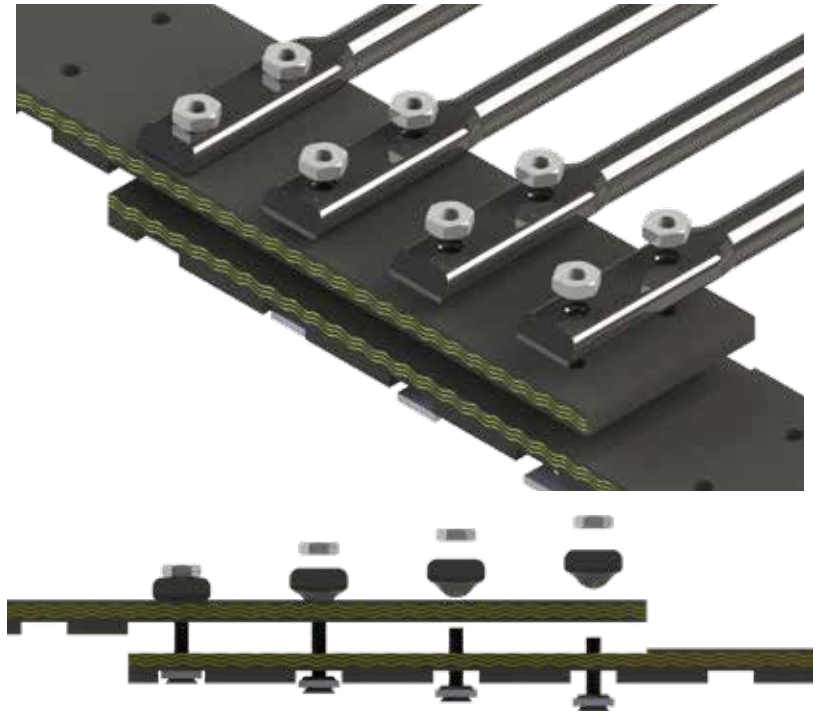

## SKIVE JOINT AND VULCANIZED

Skive joints are considered to be the strongest and most flexible joining method available. Made to reduce the bulkiness of the joint to maintain flexibility, this design is typically used in applications that require smaller diameter sprockets. Skive joints are typically made in a 6 pitch configuration. Rods can be threaded or fastened.

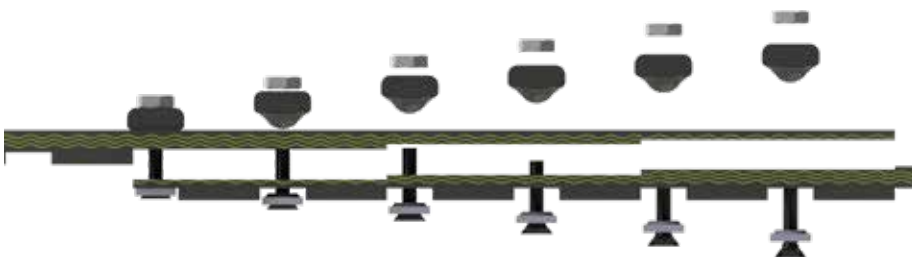
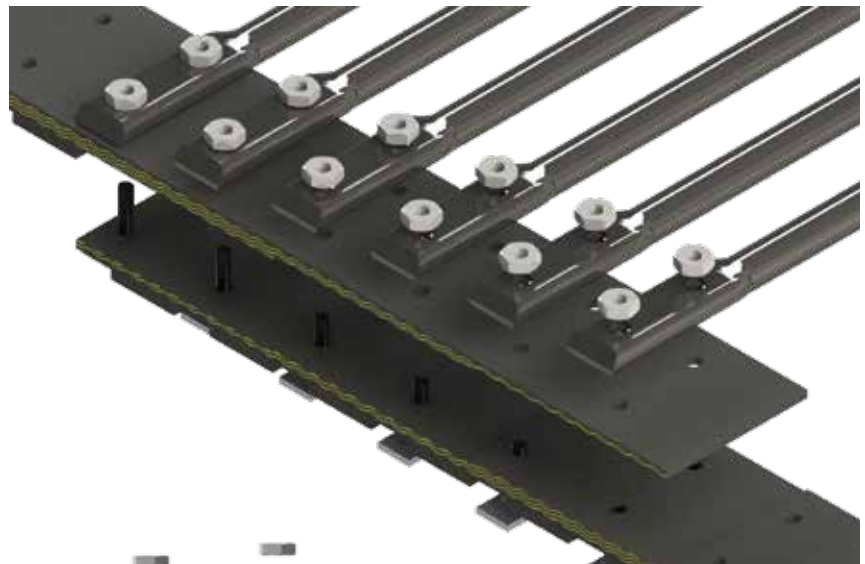

# ROD/BELT TYPES

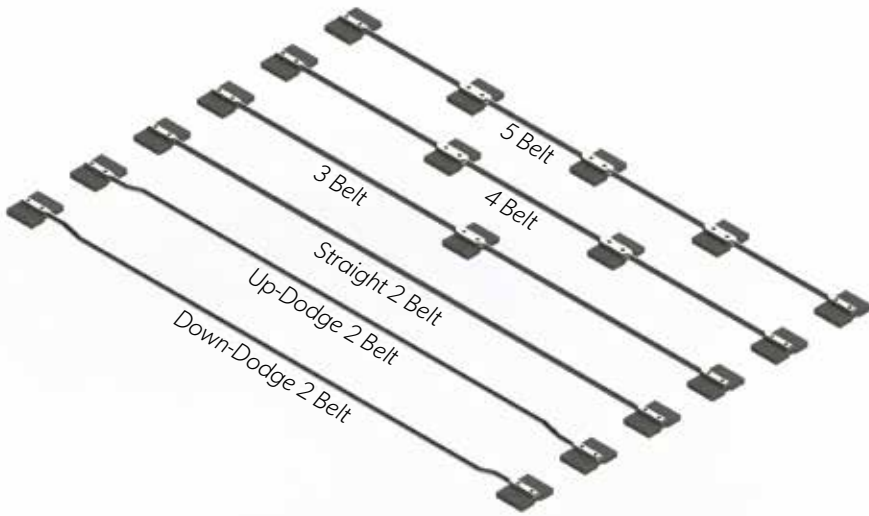

Noffsinger rods are made from high quality, American-made carbon steel. Heat treating is processed in-house and done consistently from end to end leaving no soft or brittle areas. Rods available in 3/8", 7/16", 1/2", & 5/8" diameter.

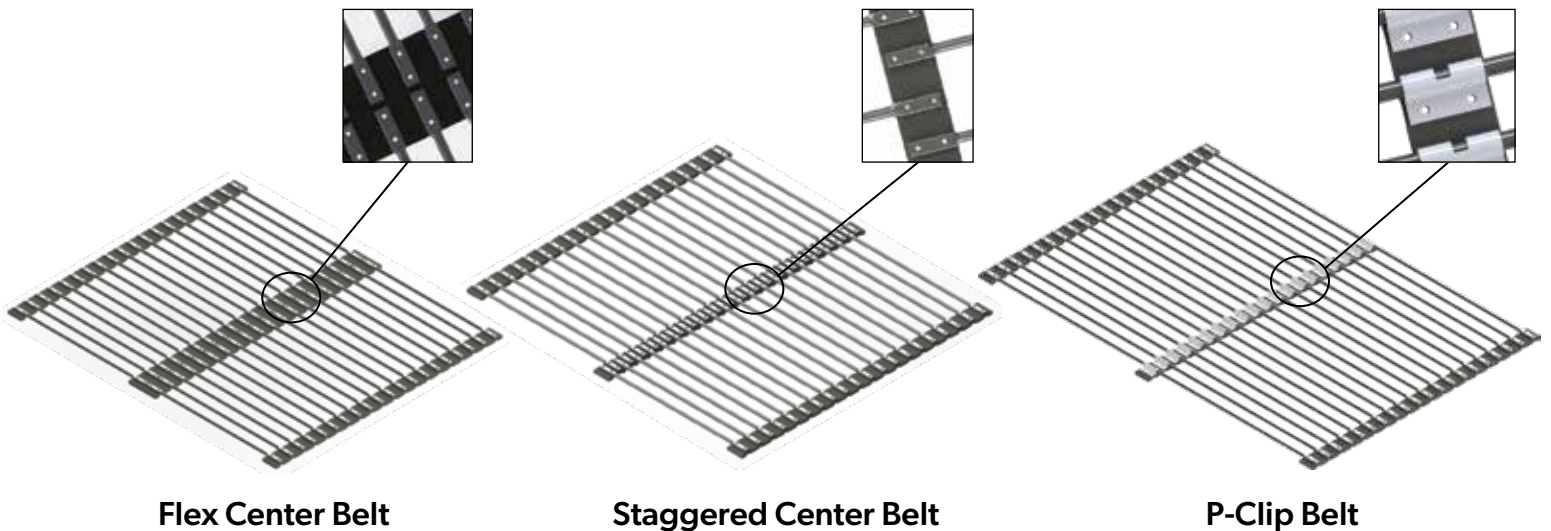
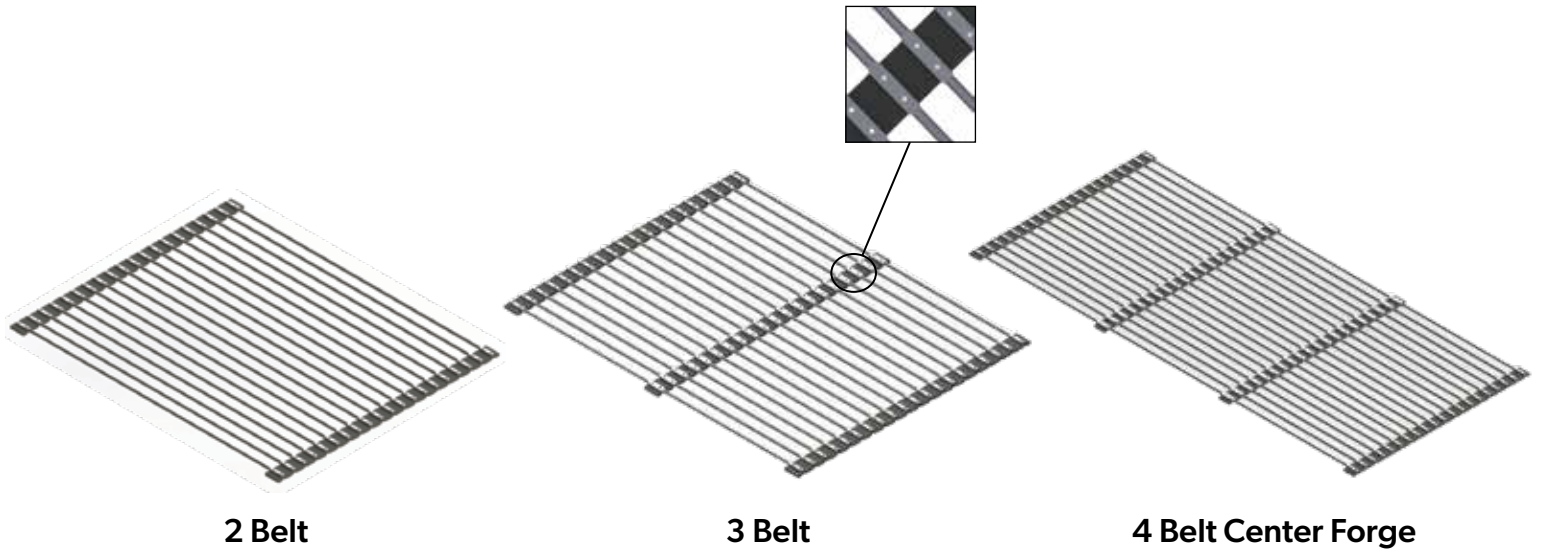

Common configurations are shown above. Rods can be patterned (up dodge, down dodge, plain, choice of covering, flight etc.) according to customer specifications.

## COVERINGS (BONDED)



### Soft Rubber Tube (SRT)

An economical covering for use in normal applications. Soft rubber tube is durable and offers good bruise protection.



### Rubber Tube (RT)

The most durable of all of the coverings, this product provides adequate bruise protection under challenging conditions.



### Plastisol (PC)

Plastisol process bonds the material to the rod giving you excellent long lasting bruise protection.



### Cushion Cell (C-Cell)

Also known as Pillow Cushion, this is a moderately priced covering for use in normal applications. Cushion cell offers excellent bruise protection in a product that has moderate durability.



### Cushion Dome (C-Dome)

C-Dome provides good all around protection in a wide variety of conditions.



### C-Flex (Bonded)

C-Flex provides very good bruise protection, durability and cleans well.

## COVERINGS (MOLDED)



### C-Flex (Molded)

The best all around product, C-Flex provides very good bruise protection is quite durable and cleans well under any conditions.



### With Ears

Optional Ears add protection over rod ends.

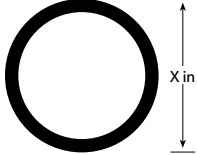
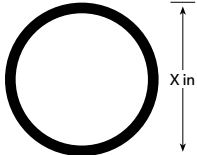
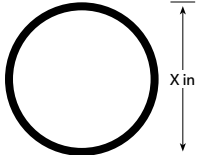
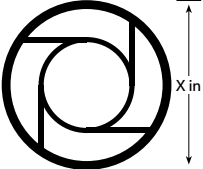
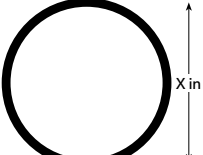
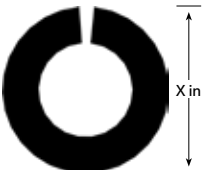
Diameter for Coverings					
		Rod Diameter			
	2D View	3/8	7/16	1/2	5/8
SRT		.69"	.75"	.88"	1"
RM			.62"	.75"	
PC		.62"	.69"	.8"	.94"
C-Cell			.81", 1", 1.62"	1"	1.19"
RT		.62"	.69"		
PVC		.62"	.69"		

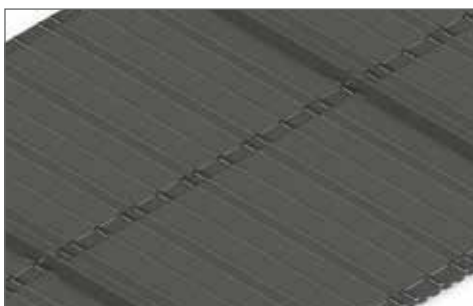

## TURF BELT

Turf Belt is a great way to create a solid self-supporting convey system for silage or other fine materials. Rods support the belt eliminating the need for full width idlers or a solid conveyor floor.



## STANDARD FLIGHT

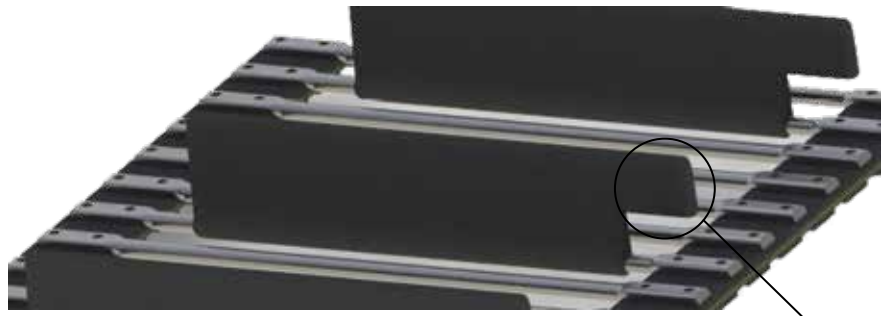

*Without Ears(S)*

*With Ears(B)*

## EXTRUDED FLIGHT

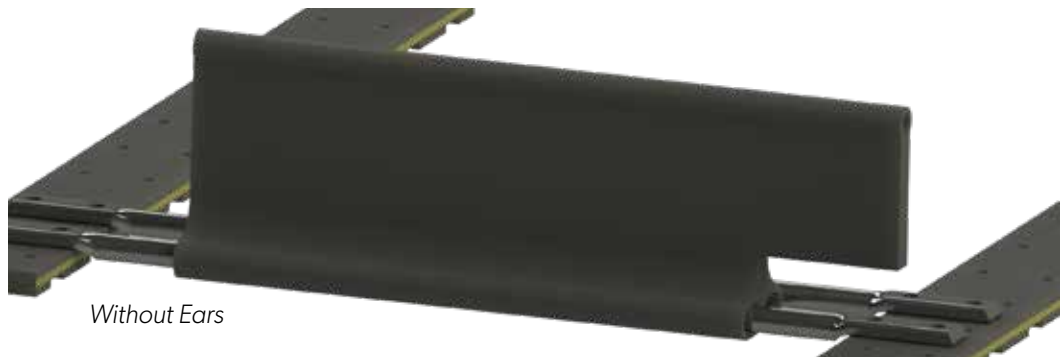

*Without Ears*

*With Ears*

## RUBBER MOLDED FINGER FLIGHTS



*Without Ears*

*With Ears*



## "A" FLIGHT

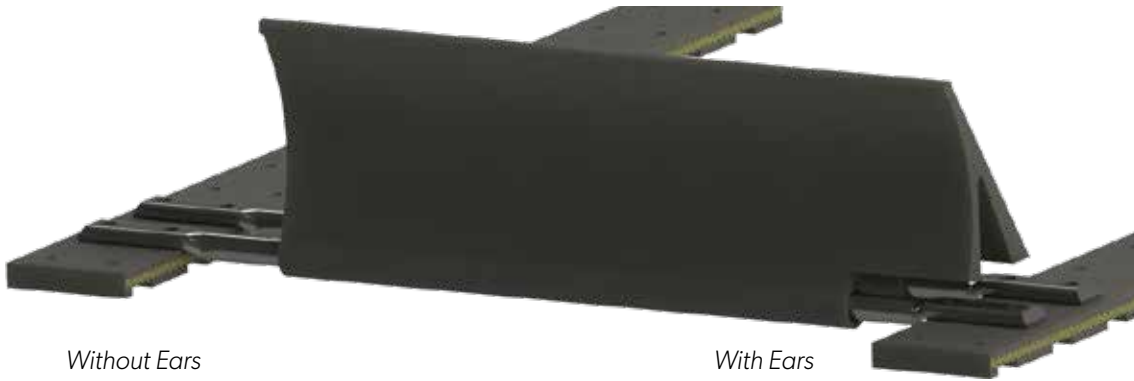

## ROP-9

P/N 119319

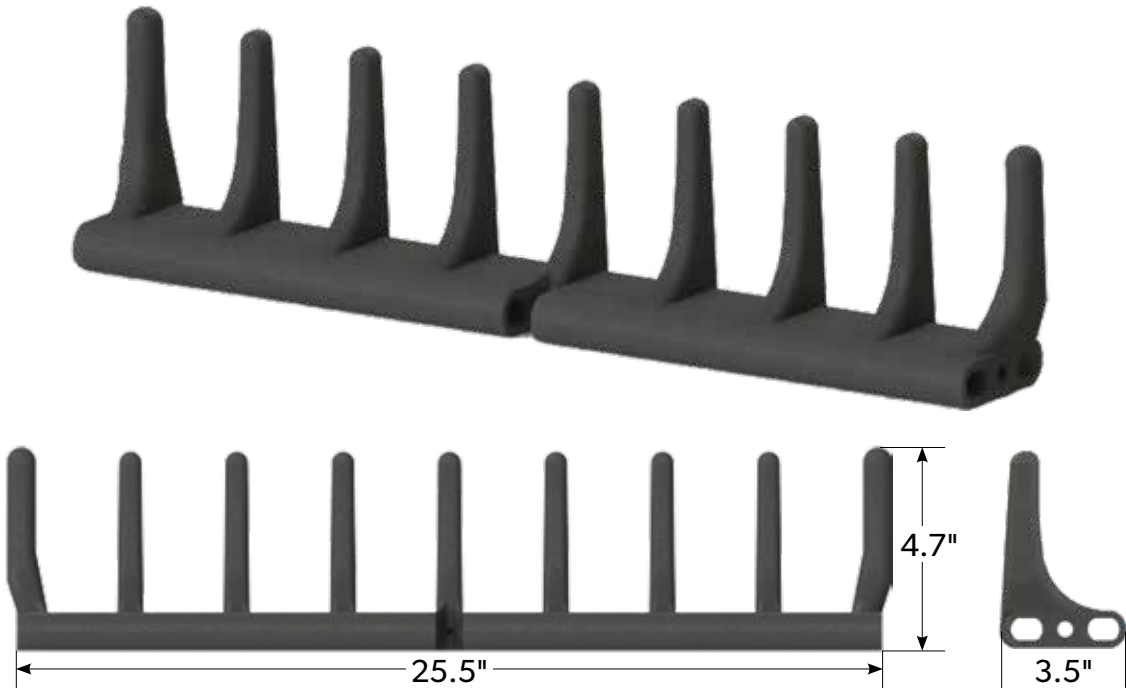

## ROP-8

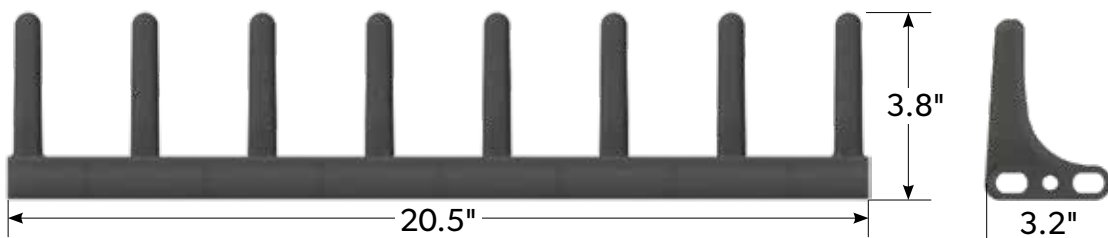

## SIDE FINGERS

P/N 118742

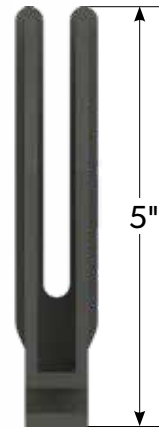

## NOF-7

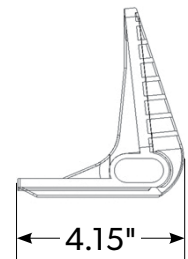
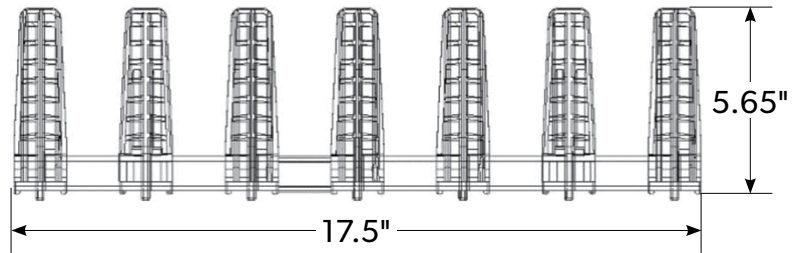
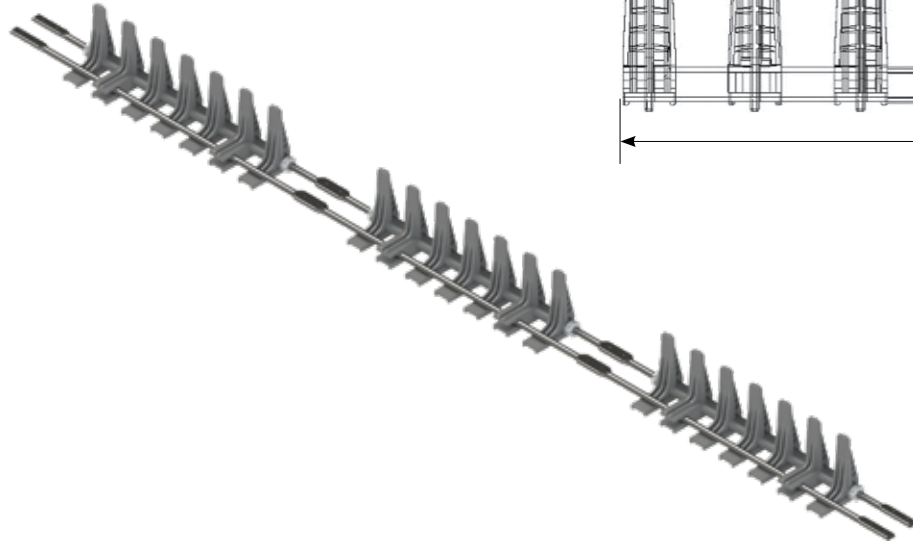

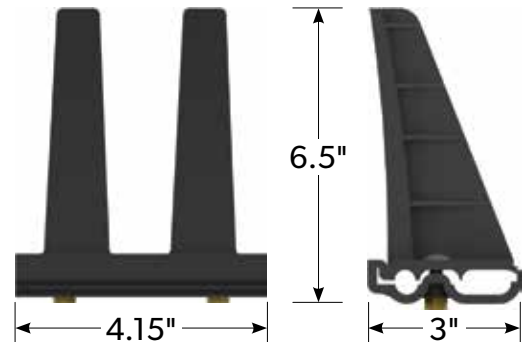

## NOF-2

P/N 120104

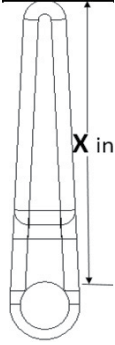
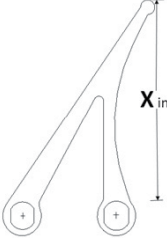

# FLIGHT DIMENSIONS

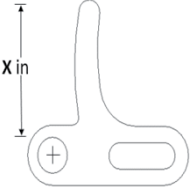
		<i>Rod Diameter</i>			
		3/8	7/16	1/2	5/8
Standard			1.5", 2.5", 3.5"	1.5", 2.5", 3.5"	
"A" Flight		2", 3", 4", 6"	2", 3", 4", 6"	2", 3", 4", 6"	
Side Wing		1.56", 2.5", 4.5"	1.56", 2.5", 4.5"		
Ext Flight		2", 3", 4"	2", 3", 4"	2", 3", 4"	2", 3", 4"

## STANDARD BRISTLE

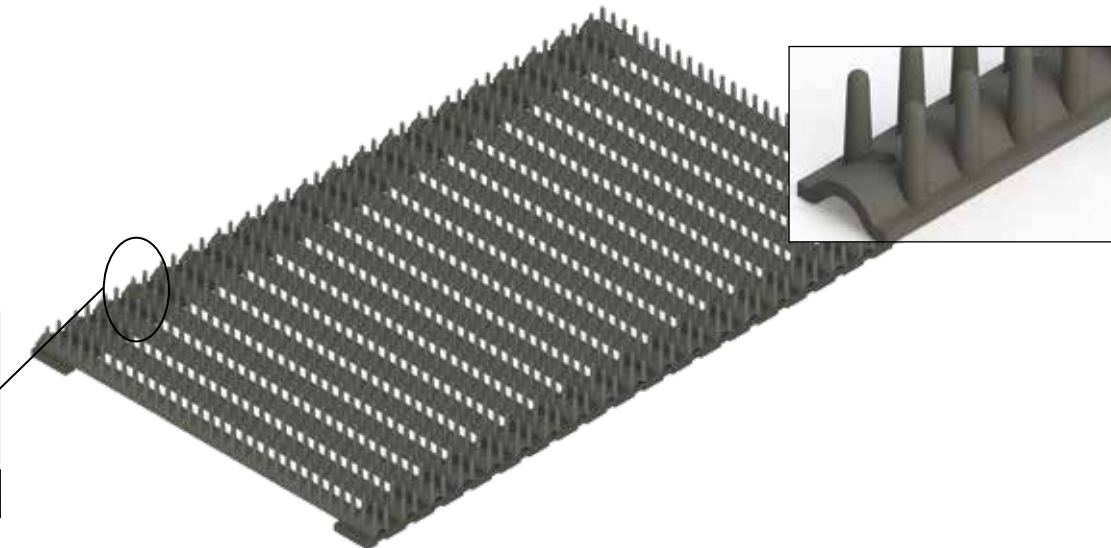
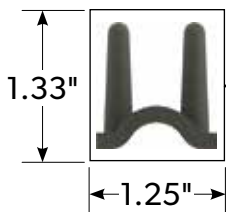

## FLAT BRISTLE

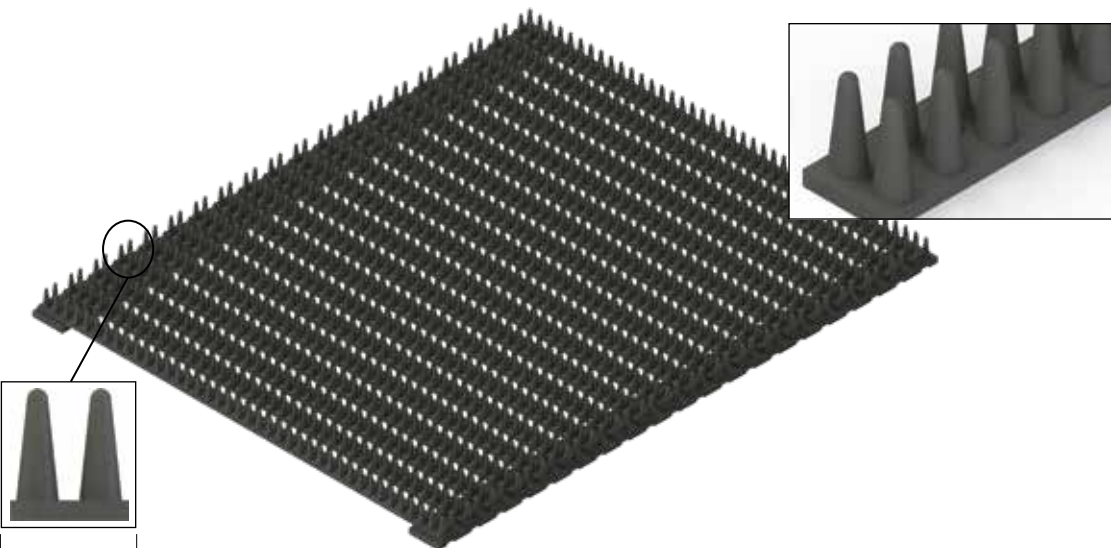
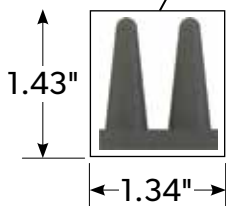

## SIDE WING

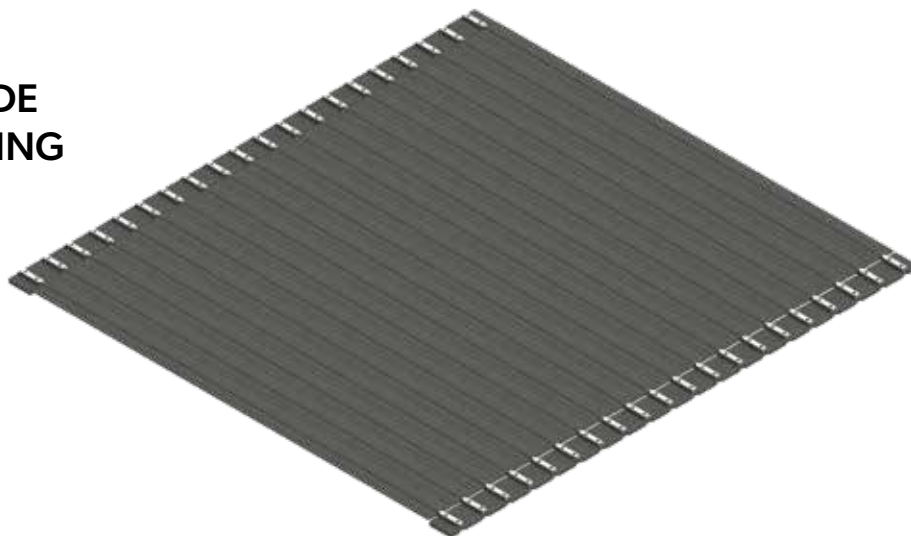

A wide variety of specialty welded products can be fabricated.

## WELDED FLIGHT

---

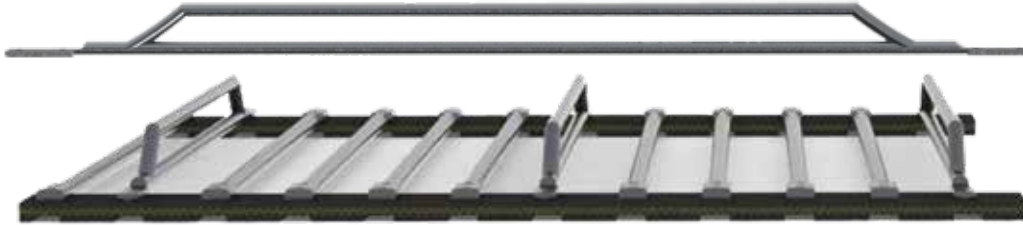

## WELDED FINGER FLIGHTS

---

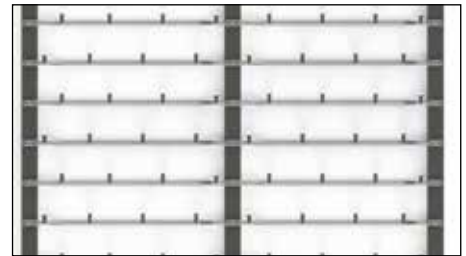

Top



Side

## ROCK TRAP

---

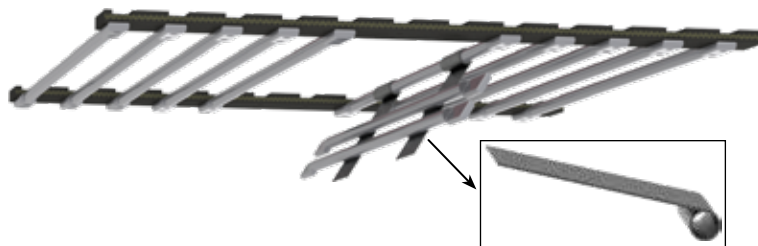

*Allows for the release of rocks or debris captured inside belt.*

## DUAL ROD WEBS

Dual rod webs are made with two rods per pitch, the smaller 5/16" rods are gapped closely together to keep in small produce. The most common application for dual rod webs are in Almonds, Noffsinger offers replacement webs for all major almonds harvester OEM's.

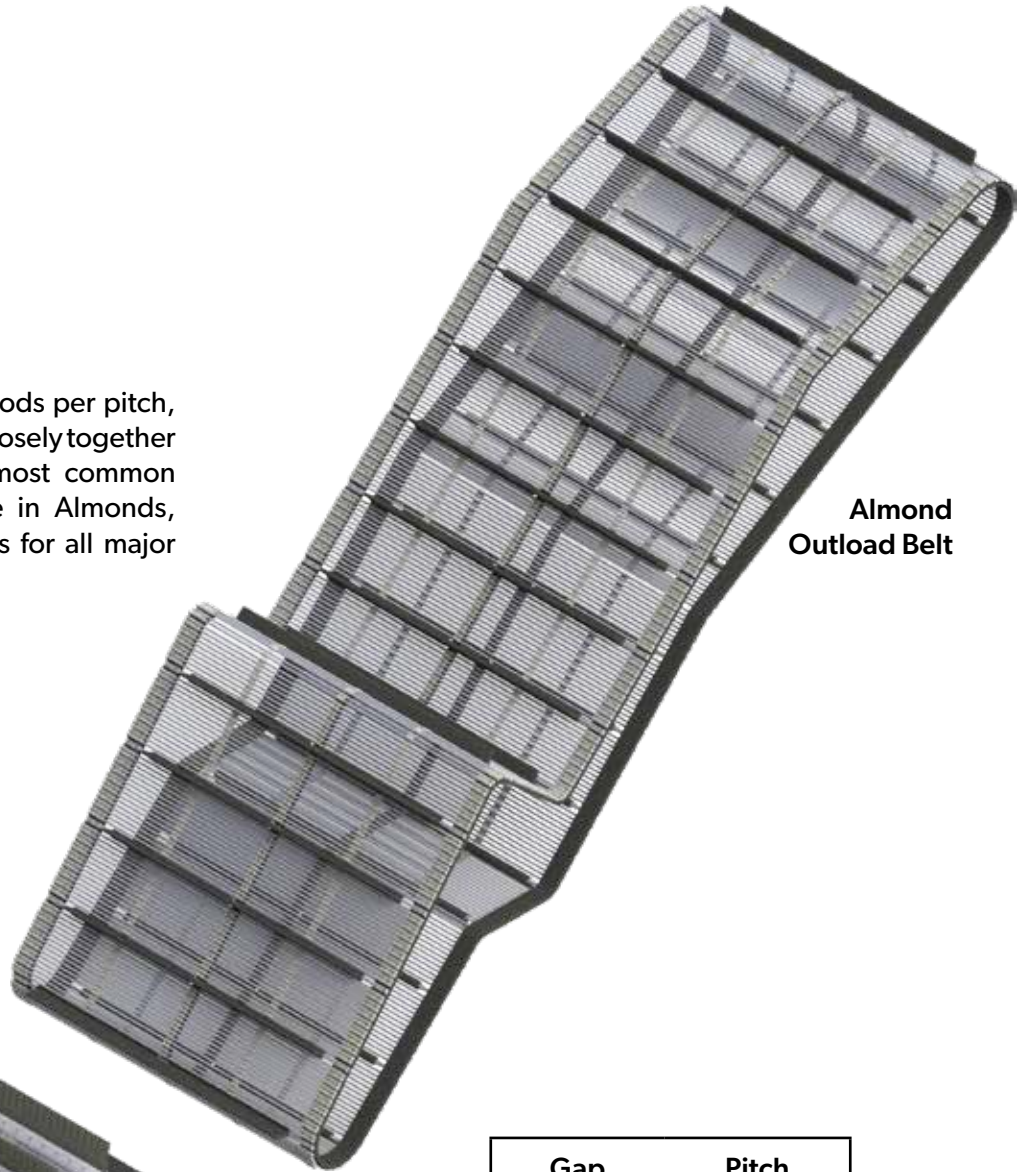

**Almond  
Outload Belt**

**Almond  
Pick Up Belt**

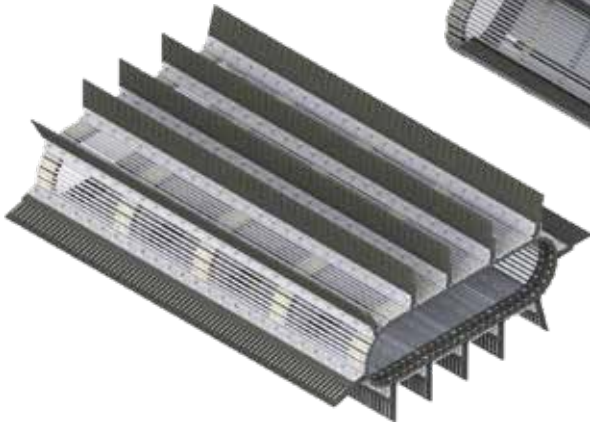

Gap	Pitch
5.5mm	27mm
7mm	30mm
9mm	34mm



Dual rod flights are specifically made with a wider base to narrow the gap and collect smaller produce, these are offered in multiple heights from 3/4" to 1-3/4"

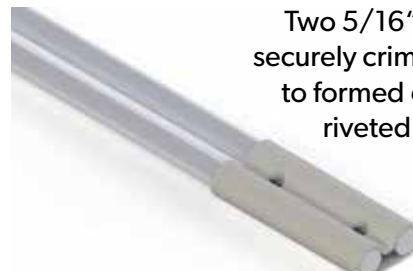

Two 5/16" steel rods are securely crimped and welded to formed clips which are riveted to the belt.

# ORDERING INFO

When placing your order for Belted Chain, please provide the following information.

**1. Rod Diameter**

38 = 3/8"  
 44 = 7/16"  
 50 = 1/2"  
 62 = 5/8"  
 Etc.

**2. Overall Belt Width**

1725 = 17-1/4"  
 3000 = 30"  
 4200 = 42"  
 Etc.

**3. Number of Belts & Belt Size**

260 = 2Belts, 60mm wide  
 275 = 2Belts, 75mm wide  
 360 = 3Belts, 60mm wide  
 375 = 3Belts, 75mm wide  
 Etc.

**4. Pitch in Millimeters**

Available sizes:  
 18mm-300m.

**5. LPR (Links per Roll)**

\*all rods and master rod

**6. Patterns**

\*Reference any up or down offset rods and coverings

**7. Joining Method**

HT = Clips  
 LP = Lap  
 SK = Skive  
 VL = Vulcanized.

**Notes:**

The following are standard unless requested otherwise.  
 All belts made with standard profile belting, threaded clips, and 1.25" sprocket run.

## EXAMPLE OF ORDERING DESCRIPTION

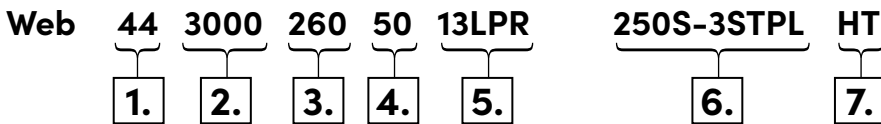

6. Pattern= 1 Flight & 3 Straight Plain

3. # of Belts & Belt Size=260

4. Pitch(mm)

